

**Directions: Use Ohms law to solve each problem. You must show your work, and circle your answer.**

1. A resistance of  $30\Omega$  is placed in a circuit with a 90 volt battery. What current flows in the circuit?
2. A motor with a resistance of  $32\Omega$  is connected to a voltage source. Four amps of current flows in the circuit. What is the voltage of the source?
3. A transistor radio uses 2 amps of current when it is run by a 9 volt battery. What is the resistance in the radio circuit?
4. An E.M.F. Of 75 volts is placed across a 15 ohm fixed resistor. What current flows through the resistor?
5. A current of 5 amps flows through a lamp when it is connected to a 110 volt power source. What is the resistance of the lamp?
6. A resistance of 60 ohms allows 0.4 amps of current to flow when it is connected across a battery. What is the voltage of the battery?
7. What current flows through a 15 ohm fixed resistor when it operates on a 120 volt outlet?

8. The resistance of an electric stove burner element is 11 ohms. What current flows through this element when it runs off a 220 volt line?

9. What voltage is applied to a 20 ohm fixed resistor if the current through the resistor is 1.5 amps?

10. What is the resistance of a lamp that is connected to a 110 voltage source that draws 2 amps of current?

Use Ohms Law ( $V=IR$ ) to calculate the unknown value. **You must show your work, and circle your answer.**

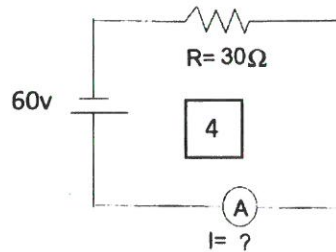
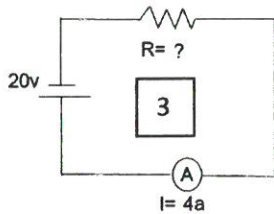
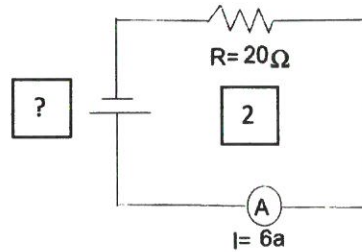
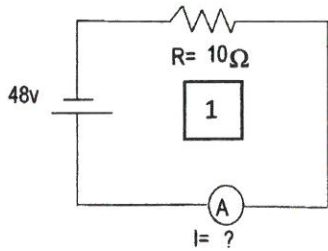

# Power System

# Worksheet

1. Identify the following components.

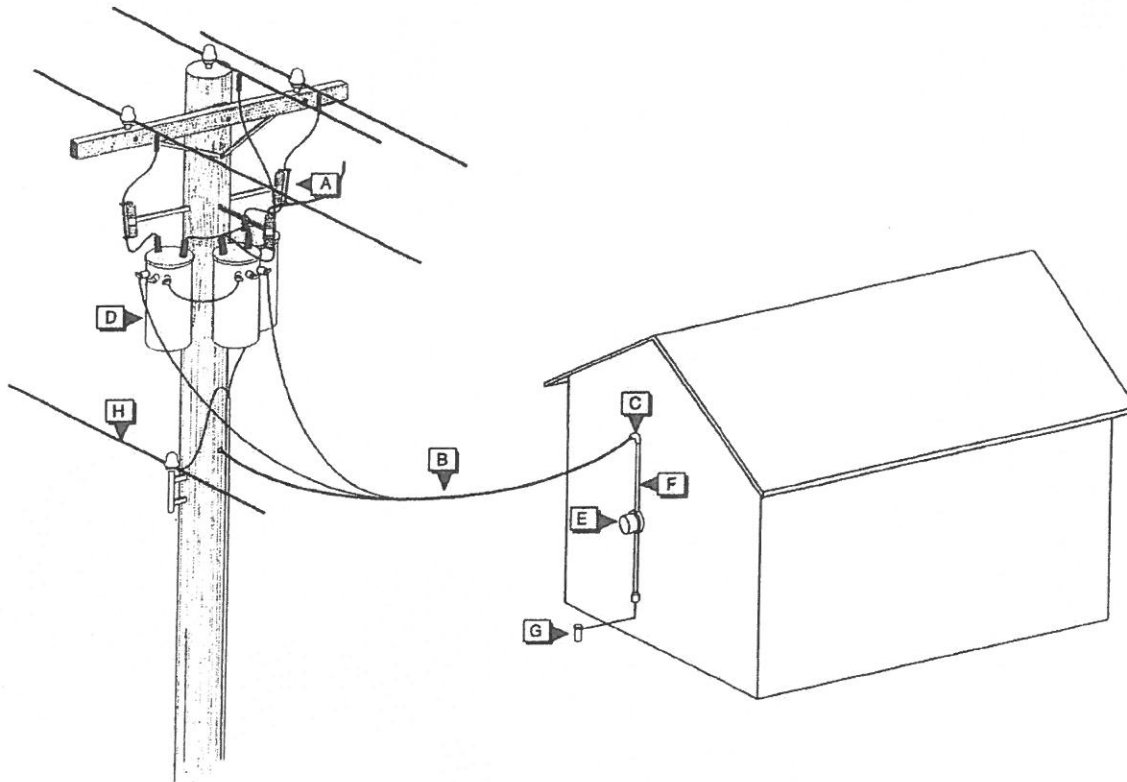

A. \_\_\_\_\_

B. \_\_\_\_\_

C. \_\_\_\_\_

D. \_\_\_\_\_

E. \_\_\_\_\_

F. \_\_\_\_\_

G. \_\_\_\_\_

H. \_\_\_\_\_

2. For a transformer to be able to induce 100V in the secondary with 1,000V in the primary, the turns ratio has to be \_\_\_\_\_ to \_\_\_\_\_.
3. If a current of 20 amps flowed in the primary portion of the above transformer, there would be a current of \_\_\_\_\_ amps in the secondary.
4. Transformers are primarily used to \_\_\_\_\_ or \_\_\_\_\_ voltage.
5. One horsepower is equal to \_\_\_\_\_ watts.

# Understanding Electrical Meters

Voltage = \_\_\_\_\_

DMM measures \_\_\_\_\_

The light bulb has \_\_\_\_\_

This type of meter Measures \_\_\_\_\_

Voltage sources

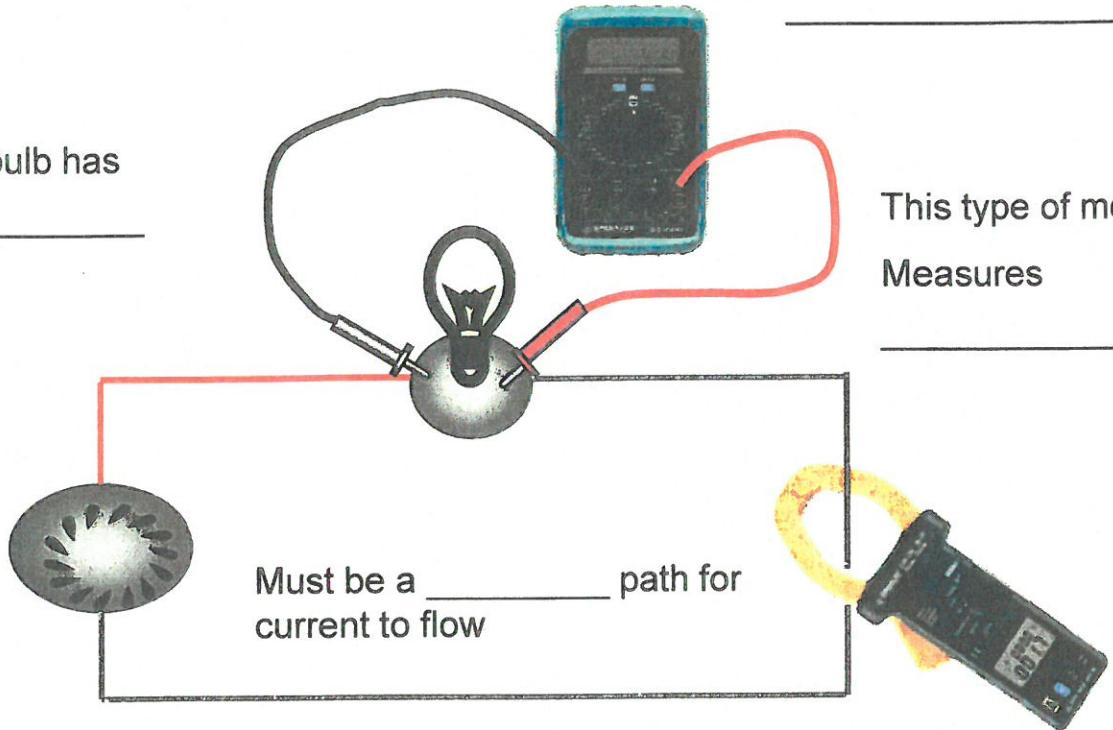

## Six ways to produce electricity?

1. \_\_\_\_\_
2. \_\_\_\_\_
3. \_\_\_\_\_
4. \_\_\_\_\_
5. \_\_\_\_\_
6. \_\_\_\_\_

# OSHA requirements

## Safe Working Voltage:

“Energized parts that operate at less than \_\_\_\_\_ volts are not required to be de-energized to satisfy an electrically safe work condition.

What is your Company's Safe Working Voltage?

## Requirements for Working on or Near Exposed Energized Parts

Always \_\_\_\_\_ (LOTO) if possible

Observe approach boundary requirements for both \_\_\_\_\_ and \_\_\_\_\_ hazards

Obtain \_\_\_\_\_ (EWWP) as required

Keep \_\_\_\_\_ persons outside of Limited Approach Space

Only \_\_\_\_\_ persons may *temporarily* override interlocks

What are the three hazards associated with Electricity ?

\_\_\_\_\_, \_\_\_\_\_ and \_\_\_\_\_

## When in the Flash Protection Boundary I should?

Wear appropriate \_\_\_\_\_ rated clothing.

Use \_\_\_\_\_ rated tools.

Use Class \_\_\_\_\_ rated Hardhat

Use \_\_\_\_\_ Face Shield.

Wear proper class \_\_\_\_\_ with \_\_\_\_\_ protectors.



# Working with Industrial Electricity

## Working Safely with Industrial Electricity

- True or False: The Occupational Safety and Health Administration (OSHA) regulates workplace safety.
- The NFPA \_\_\_\_\_ is the document used by OSHA to determine your compliance with safe work practices.
- OSHA considers less than \_\_\_\_\_ volts a safe working voltage.

## What do I need to do to make sure I go home every day?

- Am I following my companies LOTO procedures? Yes or No
- Do I need Arc Flash Safety Training (70E), LOTO training? Yes or No
- Who determines what PPE I should use at my plant? \_\_\_\_\_

Establishing Electrically Safe Work Conditions - LOTO	
<b>Principles of LOTO Execution 120.2(B)</b> <ol style="list-style-type: none"> <li>1. Employee involvement</li> <li>2. Training</li> <li>3. A plan with drawings</li> <li>4. Control of energy</li> <li>5. Unique identification</li> <li>6. Voltage removed &amp; verified</li> <li>7. Coordinated procedures</li> </ol>	<b>Responsibility for LOTO 120.2(C)</b> <ol style="list-style-type: none"> <li>1. Employer establishes procedures and provides training on these procedures</li> <li>2. Two forms of control permitted               <ol style="list-style-type: none"> <li>a. Simple LOTO</li> <li>b. Complex LOTO</li> </ol> </li> <li>3. Audit procedures (Annually)</li> </ol>
<b>Review Procedures for Hazardous Energy Control 120.2(D)</b> <ol style="list-style-type: none"> <li>1. Simple lockout/tagout procedure</li> <li>2. Complex lockout/tagout procedure</li> <li>3. Coordination of procedures</li> <li>4. Training and retraining on procedures</li> </ol>	<b>Equipment 120.2(E)</b> <ol style="list-style-type: none"> <li>1. Lock application</li> <li>2. LOTO device</li> <li>3. Lockout device</li> <li>4. Tagout device</li> <li>5. Electrical circuit interlocks</li> <li>6. Control devices</li> <li>7. Procedures</li> </ol>
<b>Procedures – 120.2(F) Equipment</b>	
<b>1. Planning is required in procedures</b>	
<ol style="list-style-type: none"> <li>a. Locating sources</li> <li>b. Exposed persons</li> <li>c. Person in charge</li> </ol>	<ol style="list-style-type: none"> <li>d. Simple lockout/tagout</li> <li>e. Complex LOTO</li> </ol>
<b>2. Elements of Control must be identified</b>	
<ol style="list-style-type: none"> <li>a. De-energizing of equipment</li> <li>b. Release of stored energy</li> <li>c. Disconnecting means</li> <li>d. Responsibilities</li> <li>e. Verification procedures</li> <li>f. Testing requirements</li> </ol>	<ol style="list-style-type: none"> <li>g. Grounding</li> <li>h. Shift change</li> <li>i. Coordination</li> <li>j. Accountability of personnel</li> <li>k. Lockout/Tagout application</li> <li>l. Release for return to service</li> </ol>

## Verifying an Electrically Safety work condition

1. Verify meter works properly on \_\_\_\_\_.
2. Verify \_\_\_\_\_ voltage on circuit being tested.
3. Verify meter \_\_\_\_\_ on voltage.

## Exercise: Verify Zero Energy State on Electrical Equipment

1. Use the three-step method to verify a zero energy state
2. Wear appropriate PPE
3. Check meter on known energized source
4. Check for zero energy state
5. Check meter on known energized source
6. Always check phase – to – phase and phase – to - ground

PPE Category	PPE Requirements
1	<b>Arc-rated clothing, Minimum Arc Rating of 4 cal/cm<sup>2</sup></b> Arc-rated long-sleeve shirt and pants or arc-rated coverall Arc-rated face shield or arc flash suit hood
2	<b>Arc-rated clothing, minimum arc rating of 8 cal/cm<sup>2</sup></b> Arc-rated long-sleeve shirt and pants or arc-rated coverall Arc-rated flash suit hood or arc-rated face shield and arc-rated balaclava
3	<b>Arc-rated clothing, minimum arc rating of 25 cal/cm<sup>2</sup></b> Arc-rated long-sleeve shirt and pants or arc-rated coverall Arc-rated flash suit hood
4	<b>Arc-rated clothing, minimum arc rating of 40 cal/cm<sup>2</sup></b> Arc-rated long-sleeve shirt and pants or arc-rated coverall Arc-rated flash suit hood



# Troubleshooting Motor Control Circuits

Let's test your knowledge of Motor Controls!

---



1. What two terminals do you connect wires to that makes the contacts on the motor starter close \_\_\_\_\_?
2. What do we call the contacts that are not the main contacts \_\_\_\_\_?
3. What are the three terminals at the bottom of a NEMA overload called \_\_\_\_\_, \_\_\_\_\_, and \_\_\_\_\_?
4. What are some of the differences between **IEC** and **NEMA** motor starters \_\_\_\_\_, \_\_\_\_\_, \_\_\_\_\_?
5. How do we size a motor starter correctly \_\_\_\_\_?
6. What are the three terminals at the top of a NEMA starter called \_\_\_\_\_, \_\_\_\_\_, and \_\_\_\_\_?
7. What protects a motor from burning up \_\_\_\_\_?
8. Name some different types of overloads \_\_\_\_\_, \_\_\_\_\_, and \_\_\_\_\_?
9. How do the overloads shut down the motor starter \_\_\_\_\_?
10. Is a motor starter a load break device \_\_\_\_\_?
11. How many sets of auxiliary can be on a motor starter \_\_\_\_\_?



# Forward/Reverse Motor Control Circuits

Lets test your knowledge of Motor Controls!

1. A 3 Phase induction motor can be reversed easily by interchanging \_\_\_\_\_ of its supply leads.
2. To reverse a 3 phase motor, requires how many contactors \_\_\_\_\_ ?
3. How many **sets** of Overloads are required \_\_\_\_\_ ?
4. 3 Phase F/R motor starters have mechanical interlocks \_\_\_\_\_ ? ( T or F )
5. Auxiliary contacts ( NO / NC ) are required to interlock the control circuit of a F/R motor starter \_\_\_\_\_ ? ( T or F )
6. What is another method of obtaining an electrical interlock for the motor starter \_\_\_\_\_ ?

Identify all the components of the Forward and Reversing starter below

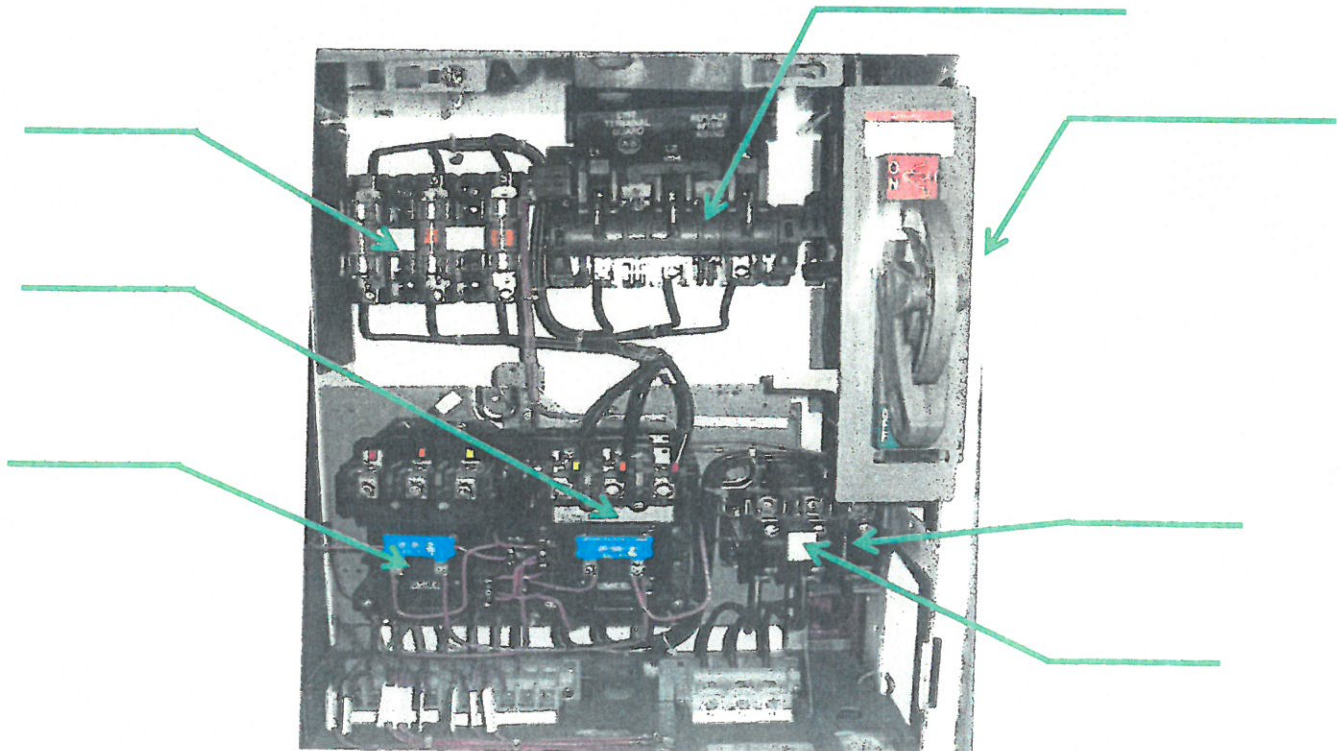

# Three-Phase Motors Operation

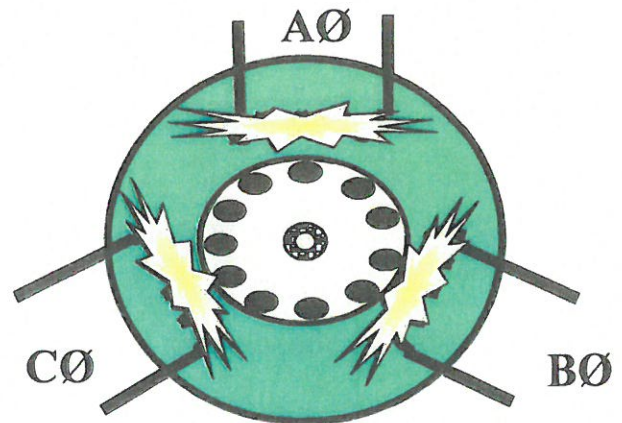
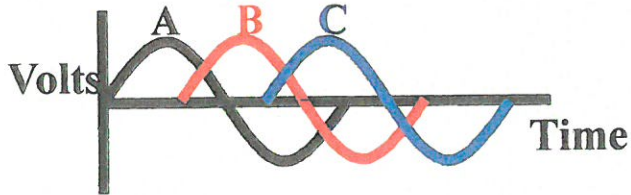

As each phase builds and returns to zero, a magnetic field builds and collapses in the same winding – The magnetic field rotates

The rotating field of the stator induces a voltage into the rotor bars producing a magnetic field about the rotor bars

The interaction of the rotor and stator magnetic fields cause rotation

- An electromechanical device used to convert electrical energy into rotating mechanical energy
- DC types
  - Series or Shunt wound
  - Compound (contains both series and shunt windings)
- AC types
  - Single-phase
  - Three-phase

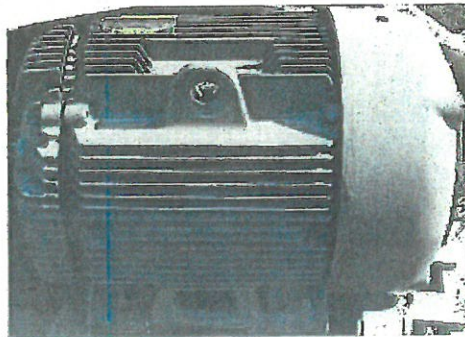



# Common Electrical Terminology

**Alternating Current (AC):** Current that flows in one direction, then reverses and flows in the opposite direction.

**Ampere: Amps (I):** The unit of measure of electrical current, the part of electricity that results in work or expended energy.

**Conductor:** An electrical property that allows the flow of electricity. Any element with one free electron in the outermost orbit.

**Direct Current (DC):** Current that flows in only one direction.

**Frequency:** The number of times a sine wave repeats in one second. Also known as cycles or Hertz (Hz).

**Harmonics:** Additional sine waves generated from the original sine wave. Third harmonics may cause overheating problems in electrical circuits.

**Induction:** The process in which an AC magnetic field causes a voltage and current to flow in another separate circuit within that magnetic field.

**Insulator:** An electrical property that restricts the flow of electricity. Any element that has five or more electrons in the outermost orbit.

**Multimeter:** An electrical instrument that can measure voltage, current, and resistance.

**Ohm:** The unit of measure of resistance in an electrical circuit.

**Overload:** Condition in which the current rating of the load is exceeded. The load attempts to perform more work than that for which it is designed.

**Phase (φ):** The live, or hot conductor. Especially if there is more than one, such as 3 phase(φ).

**Polarity:** The relationship of one coil or winding to another, clockwise and counter-clockwise.

**Potential:** The presence of voltage between two conductors.

**Resistance:** The opposition of current flow measured in ohms (Ω).

**Resistor:** A solid state device with a designated amount of resistance.

**Service:** The entrance, or connecting point, for the power source of a building.

**Short Circuit:** A circuit that has no load between the hot and neutral conductors.

**Transformer:** An electrical device, with no moving parts, that can change the voltage level.

**Volt:** The unit of measure of voltage (E).

**Watt:** The unit of measure of power used in a circuit.

# Basic Electrical Circuit

**Resistance:**  
Opposition to current flow  
measured in Ohms (Ω)

**Current:**  
The volume of electricity (number of electrons) that flow past a point in a circuit in one second measured in Amperes or Amps (A)

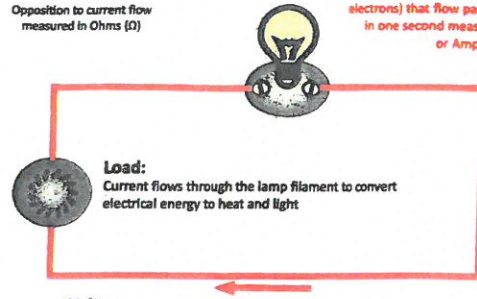

**Load:**  
Current flows through the lamp filament to convert electrical energy to heat and light

**Voltage:**  
An Electromotive force (emf) that forces electricity to flow through a circuit and is measured in Volts (V).

Voltage forces current flow through a resistance. The current returns to the source. There must be a complete path for electrical current to flow.

## Single-Phase Power

### VOLTS

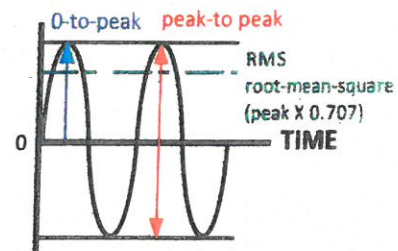

Single-Phase (1φ) Power: One complete cycle of a sine wave. North America operates at a frequency of 60 Hz (cycles per second).

## Three-Phase Power

### VOLTS

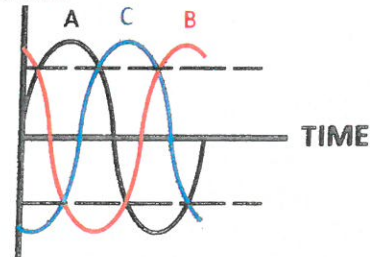

Three-Phase (3φ) Power: Consist of three separate sine waves equally spaced 120° apart. The advantage of 3φ power is more energy can be delivered to a load per unit of time. Most commercial and industrial facilities are supplied with 3φ power.

# Rules of Electricity

## Ohm's Law

One volt of electromotive force will force one amp of current flow through one ohm of resistance.

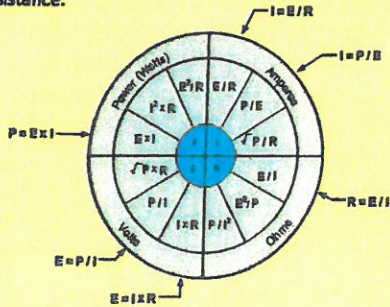

E = Voltage  
I = Current  
R = Resistance  
P = Power (watts)  
There are 3 formulas for each value

## Example:

1. What is the current in a 120 volt circuit with a load of 1800 watts?  
 $I = P/E = 1800/120 = 15$  amps

2. What is the Voltage of a circuit with a resistance of 12 Ω and a current draw of 10 amps?  
 $E = IR = 10 \times 12 = 120$  volts

## Kirchhoff's Laws

**Current:** the sum of current in a junction equals the sum of current out of the junction. (What goes in must come out)

**Voltage:** The algebraic sum of the voltage (potential) differences in any loop must equal zero. (Voltage applied equals voltage drops)



## Temporary Protective Grounding

Placed to protect employee from hazardous differences in potential.

Capacity must be sufficient size to carry fault current.

Must meet ASTM Standard F 855°

Impedance must be low enough to allow for immediate operation of protective devices.

Installing grounds is considered live work (must wear rated PPE).



## Energized Electrical Work Permit

**(1) When Required.** - When work is performed as permitted in accordance with 130.2(A), an energized electrical work permit shall be required and documented under any of the following conditions:

- (1) When work is performed within the restricted approach boundary
- (2) When the employee interacts with the equipment when conductors or circuit parts are not exposed but an increased likelihood of injury from an exposure to an arc flash hazard exists

**(2) Elements of Work Permit** - The work permit shall include, but not be limited to the following items:

- (1) Description of the circuit and equipment to be worked on and their location
- (2) Description of the work to be performed
- (3) Justification for why the work must be performed in an energized condition [see 130.2(A)]
- (4) Description of the safe work practices to be employed [see 130.3(A)]
- (5) Results of the shock risk assessment [see 130.4(A)]
  - a. Voltage to which personnel will be exposed
  - b. Limited approach boundary [see 130.4(E), Table 130.4(D)(a), and Table 130.4(D)(b)]
  - c. Restricted approach boundary [see 130.4(F), Table 130.4(D)(a), and Table 130.4(D)(b)]
  - d. Personal and other protective equipment required by this standard to safely perform the assigned task and to protect against the shock hazard [see 130.4(E), Table 130.7(C)(1) through (C)(16), and 130.7(D)]
- (6) Results of the arc flash risk assessment [see 130.5]
  - a. Available incident energy at the working distance or arc flash PPE category [see 130.5]
  - b. Personal and other protective equipment required by this standard to protect against the arc flash hazard [see 130.5(F), 130.7(C)(1) through (C)(16), Table 130.7(C)(15)(c), and 130.7(D)]
  - c. Arc flash boundary [see 130.5(E)]
- (7) Means employed to restrict the access of unqualified persons from the work area [130.3]
- (8) Evidence of completion of a job briefing, including a discussion of any job-specific hazards [see 110.1(i)]
- (9) Energized work approval (authorizing or responsible management, safety officer, or owner, etc.) signature(s)

**Informational Note:** For an example of an acceptable energized work permit, see Figure J.1.

**(3) Exemptions to Work Permit** - Electrical work shall be permitted without an energized electrical work permit if a qualified person is provided with and uses appropriate safe work practices and PPE in accordance with Chapter 1 under any of the following conditions:

- (1) Testing, troubleshooting, or voltage measuring
- (2) Thermography, ultrasound, or visual inspections if the restricted boundary is not crossed
- (3) Access to and egress from an area with energized electrical equipment if no electrical work is performed and the restricted approach boundary is not crossed
- (4) General housekeeping and miscellaneous non-electrical tasks if the restricted approach boundary is not crossed

## Current vs. Sensation Results

Current	Sensation
0.3 to 3 milliamps	Tingling
3 to 10 milliamps	Muscle contraction and pain
10 to 40 milliamps	"Let-go" threshold
30 to 75 milliamps	Respiratory paralysis
100 to 200 milliamps	Ventricular fibrillation
200 to 500 milliamps	Heart clamps tight
1.5 amps	Tissue and organs start to burn

The length of time a body is exposed to electrical current, as well as the path of the current through the body, will determine the severity of electrical shock. When a person becomes electrocuted, care must be exercised to keep the rescue personnel from becoming part of the electrical circuit; otherwise, a rescuer may also become injured.

Skin Temperature	Time to Reach Temperature	Damage Caused
110°	6.0 Hours	Cell breakdown begins
158°	1.0 second	Total cell destruction
176°	0.1 second	Second degree burn
200°	0.1 second	Third degree burn

## Meters

Rating	Use
CAT I	Protected electronic equipment; high-voltage, low-energy sources derived from a high-winding resistance transformer.
CAT II	1-phase receptacle connected loads; appliances, portable tools, outlets at more than 30 feet from CAT III source or more than 60 feet from CAT IV source.
CAT III	3-phase distribution, including single-phase commercial lighting; switchgear, polyphase motors, bus and feeders, lighting systems in larger buildings.
CAT IV	3-phase at utility connection, any outdoor conductors; "Origin of installation", electricity meters, service drop from pole to building, overhead lines etc.

A greater voltage rating within a category indicates the multimeter can withstand a more powerful transient (for example, a CAT III - 1000V meter offers greater protection than a CAT III - 600V meter). However, confusion occurs when people think a higher voltage rating on a lower category meter will give better protection. A CAT II - 1000V meter will NOT protect the operator better than a CAT III - 600V meter, because the source impedance increases with the category. Even though the voltage rating could appear lower, the higher category multimeter offers transient protection several or many times higher than the lower one because of the source impedance.

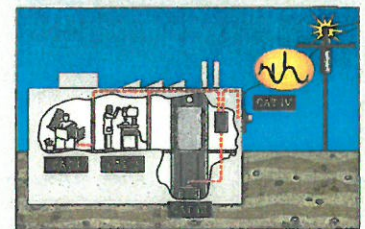

## Breakers & Fuses

Fuse Size/Inverse Time Breaker	Minimum Size of Wire	Maximum Continuous Load	Maximum Non-Continuous Load
15	14 awg	12 amps	15 amps
20	12 awg	16 amps	20 amps
25	10 awg	20 amps	25 amps
125	1/0 awg	100 amps	125 amps
150	3/0 awg	120 amps	150 amps
200	250 kcmil	160 amps	200 amps

Wire size must be an ampacity equal to or greater than the ampacity of the breaker or fuse. Example: A #12 awg wire cannot be installed to a 30 amp Breaker

NEC® Article 430 & 440 are the exception to this rule

A continuous load is any load that can run for 3 hours or more



# 120.5 Process for Establishing & Verifying an Electrically Safe Work Condition

Establishing and verifying an electrically safe work condition shall include all of the following steps, which shall be performed in the order presented, if feasible:

- (1) Determine all possible sources of electrical supply to the specific equipment. Check applicable up-to-date drawings, diagrams, and identification tags.
- (2) After properly interrupting the load current, open the disconnecting device(s) for each source.
- (3) Wherever possible, visually verify that all blades of the disconnected devices are fully open or that drawout-type circuit breakers are withdrawn to the fully disconnected position.
- (4) Release stored electrical energy.
- (5) Release or block stored mechanical energy.
- (6) Apply lockout/tagout devices in accordance with a documented & established procedure.
- (7) Use an adequately rated portable test instrument to test each phase conductor or circuit part to verify it is de-energized. Test each phase conductor or circuit part both phase-to-phase and phase-to-ground. Before and after each test, determine that the test instrument is operating satisfactorily, through verification on any known voltage source.

**Exception No. 1:** An adequately rated permanently mounted test device shall be permitted to be used to verify the absence of voltage of the conductors or circuit parts at the work location, provided it meets all the following requirements:

- (1) It is permanently mounted and installed in accordance with the manufacturer's instructions and tests the conductors and circuit parts at the point of work.
- (2) It is listed and labeled for the purpose of verifying the absence of voltage.
- (3) It tests each phase conductor or circuit part both phase-to-phase and phase-to-ground.
- (4) The test device is verified as operating satisfactorily on any known voltage source before and after verifying the absence of voltage.

**Exception No. 2:** On electrical systems over 1000 volts, noncontact test instruments shall be permitted to be used to test each phase conductor.

**Informational Note No. 1:** See UL 61010-1, *Safety Requirements for Electrical Equipment for Measurement, Control, and Laboratory Use, Part 1: General Requirements*, for rating, overvoltage category, and design requirements for voltage measurement and test instruments intended for use on electrical systems 1000 volts and below.

**Informational Note No. 2:** For additional information on rating and design requirements for voltage detectors, refer to IEC 61243-1, *Live Working - Voltage Detectors - Part 1: Capacitive type to be used for voltages exceeding 1kV a.c.*, or IEC 61243-2, *Live Working - Voltage Detectors - Part 2: Resistive type to be used for voltages of 1kV to 36kV a.c.*, or IEC 61243-3, *Live Working - Voltage Detectors - Part 3: Two-pole low voltage type*.

(8) Where the possibility of induced voltages or stored electrical energy exists, ground the phase conductors or circuit parts before touching them. Where it could be reasonably anticipated that the conductors or circuit parts being de-energized could contact other exposed energized conductors or circuit parts, apply temporary protective grounding equipment in accordance with the following:

(1) **Placement.** Temporary protective grounding equipment shall be placed at such locations and arranged in such a manner as to prevent each employee from being exposed to a shock hazard (i.e. hazardous differences in electrical potential). The location, sizing, and application of temporary protective grounding equipment shall be identified as part of the employer's job planning.

(2) **Capacity.** Temporary protective grounding equipment shall be capable of conducting the maximum fault current that could flow at the point of grounding for the time necessary to clear the fault.

**Informational Note:** ASTM F855, *Standard Specification for Temporary Protective Grounds to be Used on De-energized Electric Power Lines and Equipment*, is an example of a standard that contains information on capacity of temporary protective grounding equipment.

(3) **Impedance.** Temporary protective grounding equipment and connections shall have an impedance low enough to cause immediate operation of protective devices in case of unintentional energizing of the electric conductors or circuit parts.

# Establishing Electrically Safe Work Conditions - LOTO

Principles of LOTO Execution	Responsibility for LOTO
<ol style="list-style-type: none"> <li>1. Employee Involvement</li> <li>2. Training</li> <li>3. Retraining</li> <li>4. Training Documentation</li> <li>5. Plan</li> <li>6. Control of Energy</li> <li>7. Identification</li> <li>8. Voltage</li> <li>9. Coordination</li> </ol>	<ol style="list-style-type: none"> <li>1. Employer establishes procedures and provides training on these procedures</li> <li>2. Two forms of control permitted                             <ol style="list-style-type: none"> <li>a. Simple LOTO</li> <li>b. Complex LOTO</li> </ol> </li> <li>3. Audit procedures (Annually)</li> </ol>

Review Procedures for Hazardous Energy Control	Equipment
<ol style="list-style-type: none"> <li>1. Simple lockout/tagout procedure</li> <li>2. Complex lockout/tagout procedure</li> <li>3. Coordination of procedures</li> </ol>	<ol style="list-style-type: none"> <li>1. Lock application</li> <li>2. LOTO device</li> <li>3. Lockout device</li> <li>4. Tagout device</li> <li>5. Electrical circuit Interlocks</li> <li>6. Control devices</li> </ol>

## Procedures - Equipment

1. Planning is required in procedures	
<ol style="list-style-type: none"> <li>a. Locating sources</li> <li>b. Exposed persons</li> <li>c. Person in charge</li> </ol>	<ol style="list-style-type: none"> <li>d. Simple lockout/tagout</li> <li>e. Complex LOTO</li> </ol>

2. Elements of Control must be identified	
<ol style="list-style-type: none"> <li>a. De-energizing of equipment</li> <li>b. Release of stored energy</li> <li>c. Disconnecting means</li> <li>d. Responsibilities</li> <li>e. Verification procedures</li> <li>f. Testing requirements</li> </ol>	<ol style="list-style-type: none"> <li>g. Grounding</li> <li>h. Shift change</li> <li>i. Coordination</li> <li>j. Accountability of personnel</li> <li>k. Lockout/Tagout application</li> <li>l. Removal of Lockout/Tagout Devices</li> </ol>

Refer to NFPA 70E® Article 120.2 for additional information.

# Ground-Fault Interrupter (GFCI)

**(Ground-Fault Circuit Interrupter (GFCI).** A device intended for the protection of personnel that functions to de-energize a circuit or portion thereof within an established period of time when a current to ground exceeds the values established for a Class A device. [NEC® Article 100]

**Informational Note:** Class A ground-fault circuit-interrupters trip when the current to ground is 6 mA or higher and do not trip when the current to ground is less than 4 mA. For further information see ANSI/UL 943 Standard for Ground-Fault.

## NFPA 70E® Article 110.6 Ground-Fault Circuit-Interrupter (GFCI) Protection.

(1) **General.** Employees shall be provided with ground fault circuit-interrupter (GFCI) protection where required by applicable state, federal, or local codes and standards. Listed cord sets or devices incorporating listed GFCI protection for personnel identified for portable use shall be permitted.

(2) **Maintenance and Construction.** GFCI protection shall be provided where an employee is operating or using cord- and plug-connected tools related to maintenance and construction activity supplied by 125-volt, 15-, 20-, or 30-ampere circuits. Where employees operate or use equipment supplied by greater than 125-volt, 15-, 20-, or 30-ampere circuits, GFCI protection or an assured equipment grounding conductor program shall be implemented.

(3) **Outdoors.** GFCI protection shall be provided when an employee is outdoors and operating or using cord- and plug-connected equipment supplied by 125-volt, 15-, 20-, or 30-ampere circuits. Where employees working outdoors operate or use equipment supplied by greater than 125-volt, 15-, 20-, or 30-ampere circuits, GFCI protection or an assured equipment grounding conductor program shall be implemented.

**NFPA 70E® Article 110.6(D) Ground-Fault Circuit-Interrupter Protection Devices.** GFCI protection devices shall be tested in accordance with the manufacturer's instructions.

For more information see OSHA Sub part 5® or NFPA 70E®



# Basic Electrical Terms

- **Voltage** (measured in volts) is the electromotive force (EMF) or “push” that moves electrons along a conductor. It can also be described as the amount of electrical pressure in a circuit. Voltage is either direct current (DC) or alternating current (AC). On an electrical schematic or drawing, or in calculations, voltage is represented by the letter E.
- **Voltage drop** is the voltage loss (drop) that occurs in passive parts of the circuit (i.e. not the source) due to impedance. While some voltage drop is expected, excessive voltage drop is usually a sign that some part of the circuit is damaged. The sum of the voltage around a closed circuit is to the applied voltage. Voltage drop may cause electrical fires, improper operation of equipment, and /or equipment damage.
- **Current** (measured as amperage or amperes) is the volume of electricity (number of electrons) moving past a point in a 1 – second time period. Current is best described as the flow of electrons through an electrical circuit. Different voltage sources produce different amounts of current, depending on the impedance of the circuit. On an electrical schematic or drawing, or in calculations, current is represented by the letter I . Current will flow through a circuit when there is a continuous path between the terminals of the voltage source.
- **Resistance** is the opposition to the flow of electrons and is measured in ohms. On an electrical schematic or drawing, or in calculations, resistance is represented by the letter R. Units of resistance are **ohms**, represented by the omega ( $\Omega$ ) Resistance should not be measured on a circuit that is powered.
- **Impedance** is the combination of resistance and reactance (caused by magnetic fields and capacitance) in an AC circuit and is also represented by the omega ( $\Omega$ ). On an electrical schematic or drawing, or in calculations, impedance is represented by the letter Z.
- **Power** is the rate of doing work or using energy and is represented by the letter P. Power can best be described as the rate at which electrical energy is transferred by electrical circuit. It is measured in watts (W) or kilowatts (KW). A watt measures the rate of energy conversion for electrical and electromagnetic applications; a kilowatt equals 1,000 watts. Kilowatts are used to describe the output power of engines as well as the power consumption rate of electric motors and tools. As a point of comparison, a window fan uses about 200 watts, while a dishwasher might use up to 2,400 watts or 2.4 kilowatts.
- **True power** is the actual power dissipated by a load and is expressed in watts (W). **Reactive power** is the power in a circuit that is lost to magnetic fields and capacitance. Reactive power is measured in the unit of volt-amps-reactive (VAR). **Apparent power** is the total power in the circuit (dissipated and absorbed power) and is measured in the unit of volt-amps (VA). The unit kVA represents 1,000 volt-amperes.



## Basic Electrical Terms

- **Capacitance** is the ability to hold an electric charge, or the property of an electric circuit that opposes changes in voltage. Capacitance is measured in ohms and directly opposes inductive reactance in an AC circuit. A capacitor is any device that stores electrical energy using an electrostatic field.
- **Inductance** allows voltage to be generated proportional to the rate of change in a circuit. Inductance reactance is also measured in ohms and directly opposes capacitance in an AC circuit
- **Impedance** is the total opposition to current flow in an AC circuit and is the result of resistance, capacitive reactance, and inductive reactance.
- **Ampacity** is the maximum amount of electrical current that a cable can carry before exceeding its temperature rating, deteriorating or failing.
- **A load** is any device that converts electrical energy to motion, light, heat, or sound. A load might be something like a heating coil, a lamp, or a motor. Loads can either be inductive loads (such as motors or transformers) or resistive loads (such as incandescent lighting or resistance heat).
- An electrical **fault** is any abnormal flow of electrical current. **Grounding** refers to connecting an electrical circuit to the earth (ground) in order to minimize and prevent contact with dangerous voltage. It can refer to circuits that have no physical connection to the earth; in this case, what is called the ground connection refers to the return circuit path for the electrical current and is often referred to as a common. A **ground fault** occurs when a circuit in this system sends current through the earth (or return circuit) at a sufficiently high current to be dangerous. A ground-fault circuit interrupter (GFI or GFCI) is a circuit breaker that is designed for use in wet or hazardous locations—they are quite common in bathroom and kitchen outlets and will be used in the kitchens, outside, in garages, or in any wet location. The GFI is a thermal-magnetic breaker that also detects leak to the ground; if this current leak exceeds 4-6 milliamperes, the circuit is broken. (A milliampere (.mA) is 1/1000 of an ampere.)
- **Bonding** refers to deliberately connecting (electrically) all metal parts in a system that do not carry current. This means that all these parts have the same electrical potential, and differences in current do not exist, reducing the electrical danger.

